

1PXL Board CW/WW/DW

1PXL Board White offers crisp shades of cold/warm/dynamic white. The slim profile TX Connect™ LED board is designed for backlighting of walls, floors, ceilings, or any other flat surface that allows you to optimize the color temperature to changing ambients. Auto-addressing allows this board to maximize the number of fixtures controlled within a DMX universe.



Product Specifications

Model	Cold White (CW)	Warm White (WW)	Dynamic White (DW)
Light Source	16 High intensity SMT LEDs	16 High intensity SMT LEDs	32 High intensity SMT LEDs (16 Cold White + 16 Warm White LEDs)
Color Temperature	6500K	2700K	2700K - 6500K
Beam Angle	120°		
Luminous Flux	269.7 lm	172.4 lm	445.4 lm
Efficacy	38.37 lm/W	23.9 lm/W	30.6 lm/W
LED Pitch	62.5mm / 2.46"		
Dimensions (L x W x H)	230 x 230 x 11.5mm 9.06" x 9.06" x 0.45"		
Weight	200g / 0.4lbs		
Regulatory Listing & Safety Approval	CE, FCC		
Operating Temperature	0°C to 40°C / 32°F to 104°F		
Storage Temperature	-20°C to +70°C / -4°F to 158°F		
Environment	Indoor		
Humidity	0 to 90% non-condensing		

Electrical Specifications

Input Voltage	24V DC		
Power Consumption	8W max.	8W max.	15W max.

System Specifications

Power / Data Interface	TX CONNECT Smart Indoor		
Control	DMX512, 3 channels per pixel		
Power Supply	LED Engine Smart 100W Indoor		
Addressing Options	DMX Auto-Addressing ON/OFF (See Auto-Addressing Configuration for details)		

LED CHARACTERISTICS Because LEDs are semiconductor devices, their performances are subject to inherent variability commonly found in semiconductor industry. To improve consistency in performance across the same product, LED manufacturers "sort" LEDs into bins according to different preset parameters, such as forward driving voltage, illumination, etc. Whereas binning is a sorting function, it is not a correction process. Inherent variability in the manufacturing process results always in different binning distributions according to different production lots. Traxon uses automatically binned LEDs on its products, thereby minimizing output variations within the model range.

As with all electronic devices, LED output degrades over time – a term called lumen depreciation. This also explains why it is nearly impossible to expect photometric performances of two LED products with different service life spans to be the same. The rate of LED degrade is a complicate function of many factors such as operating efficiency, duration of continuous operation, and more significantly, environmental conditions (ambient temperature for example). If allowed working under optimal operating temperature range and with good ventilation, LED devices enjoy long service lives over conventional light sources. When using/installing LED devices, care should be taken to ensure that the devices will operate within the operating conditions specified in respective product literature.

Source Specifications

Source	16 LEDs Cold white
Optics	120°
Distribution	Symmetric direct illumination
CCT	6500K
CRI	81.9

Candela Distribution

Light Output

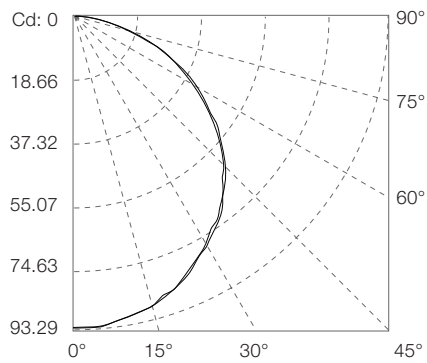

Luminous Flux (lm)	Power (Watts)	Efficacy (lm/W)
269.71	7.03	38.37

- Beam angle (50% I_{max}): 114.4°

Illuminance

Distance	10cm/3.9"	25cm/9.8"	50cm/19.7"	72cm/29.5"	100cm/39.4"
Lux	9236	1478	369	164	92
50% I _{max} (diameter)	31cm/12.2"	78cm/30.5"	155cm/61.1"	233cm/91.6"	310cm/122.2"

Illuminance at a Distance

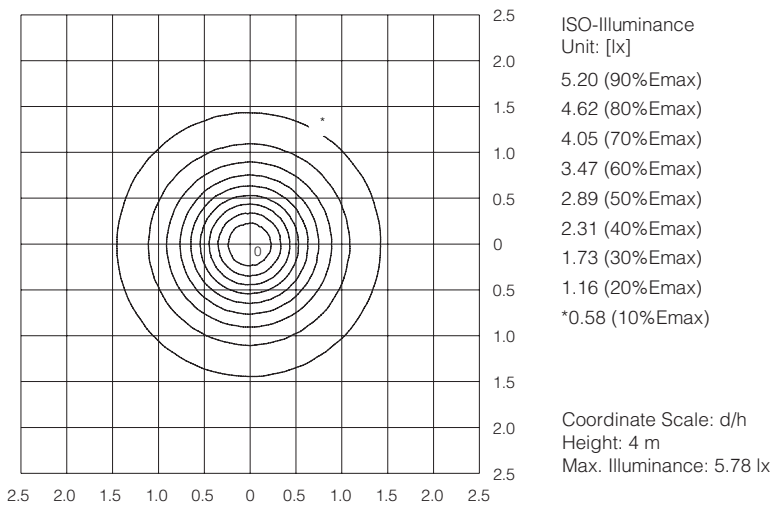

Photometric measurements are carried out by an independent laboratory.
IES and LDT files are available for download from the Traxon website.

Source Specifications

Source	16 LEDs Warm white
Optics	120°
Distribution	Symmetric direct illumination
CCT	2700K
CRI	71.6

Candela Distribution

Light Output

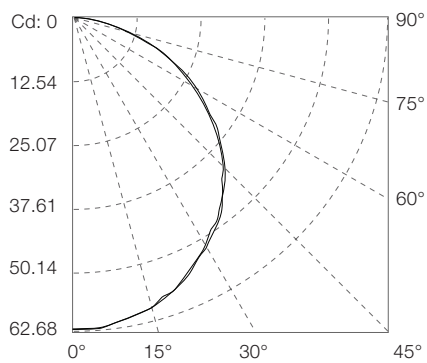

Luminous Flux (lm)	Power (Watts)	Efficacy (lm/W)
172.36	7.2	23.94

- Beam angle (50% I_{max}): 110.5°

Illuminance

Distance	10cm/3.9"	25cm/9.8"	50cm/19.7"	72cm/29.5"	100cm/39.4"
Lux	6191	990	248	110	62
50% I _{max} (diameter)	29cm/ 11.4"	72cm/ 28.4"	144cm/ 56.8"	216cm/ 85.1"	288cm/ 113.5"

Illuminance at a Distance

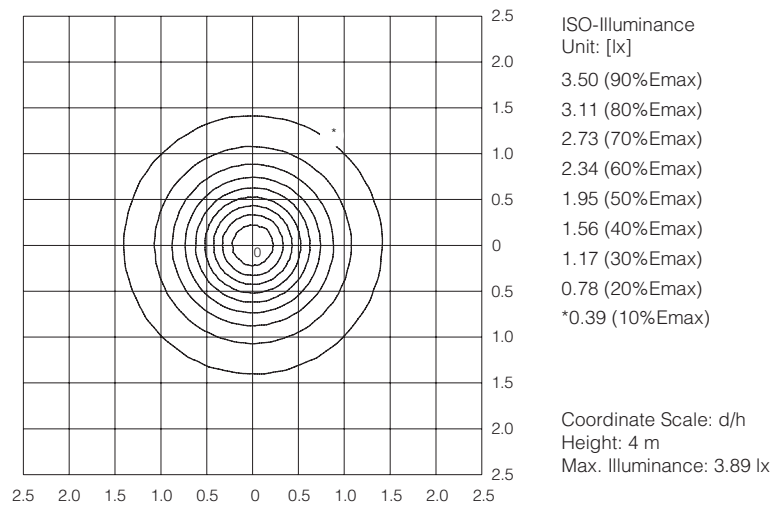

Photometric measurements are carried out by an independent laboratory.
IES and LDT files are available for download from the Traxon website.

www.traxontechnologies.com

©2016 TRAXON TECHNOLOGIES - AN OSRAM BUSINESS. ALL RIGHTS RESERVED. TRAXON™, TX CONNECT®, ARE TRADEMARKS OF TRAXON TECHNOLOGIES. U.S. PATENTS, E.U. PATENTS, JAPAN PATENTS, OTHER PATENTS PENDING. SPECIFICATIONS ARE SUBJECT TO CHANGE WITHOUT NOTICE.

Source Specifications

Source	32 LEDs Dynamic white (16 WW, 16 CW)
Optics	120°
Distribution	Symmetric direct illumination
CCT	2700 K - 6500 K
CRI	78.5

Candela Distribution

Light Output

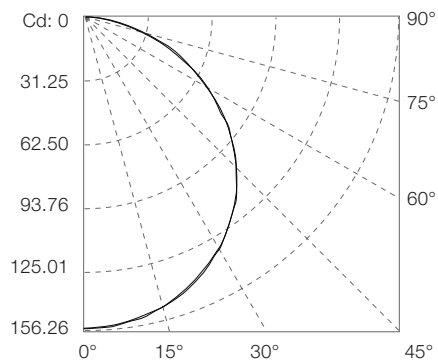

Luminous Flux (lm)	Power (Watts)	Efficacy (lm/W)
445.41	14.55	30.61

- Beam angle (50% I_{max}): 113.1°

Illuminance

Distance	10cm/3.9"	25cm/9.8"	50cm/19.7"	72cm/29.5"	100cm/39.4"
Lux	15506	2481	620	276	155
50% I _{max} (diameter)	30cm/11.9"	76cm/29.8"	151cm/59.6"	227cm/89.4"	303cm/119.2"

Illuminance at a Distance

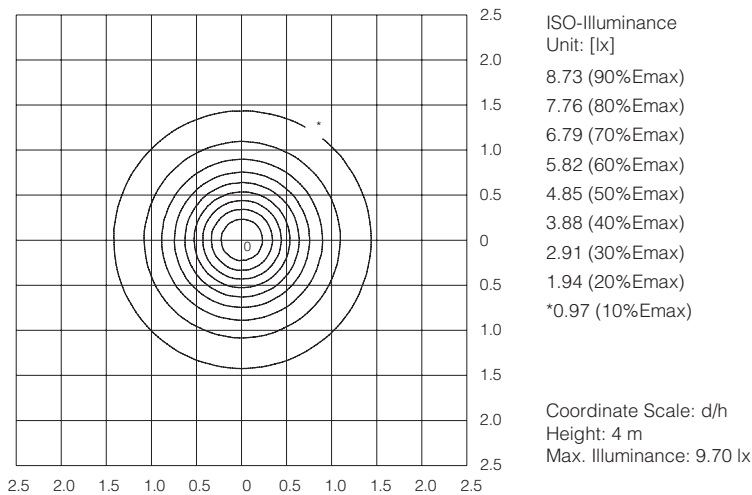

Photometric measurements are carried out by an independent laboratory.
IES and LDT files are available for download from the Traxon website.

1PXL Board CW / WW

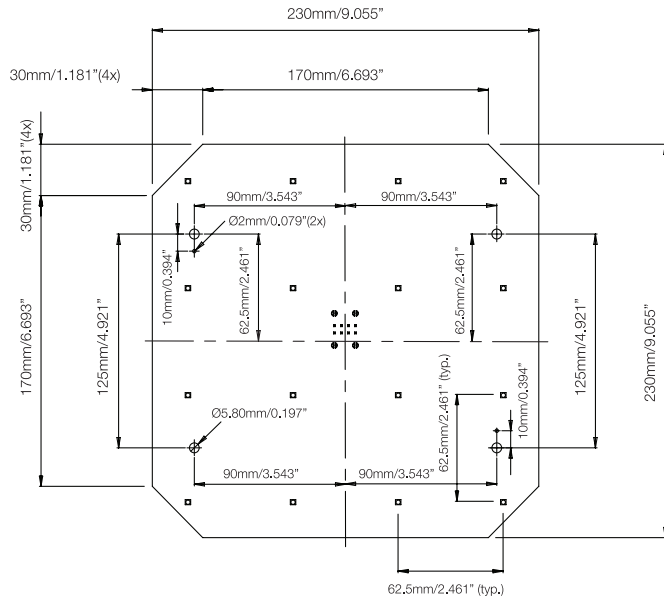

FRONT

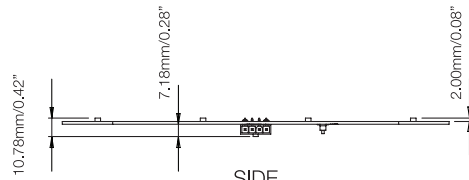

SIDE

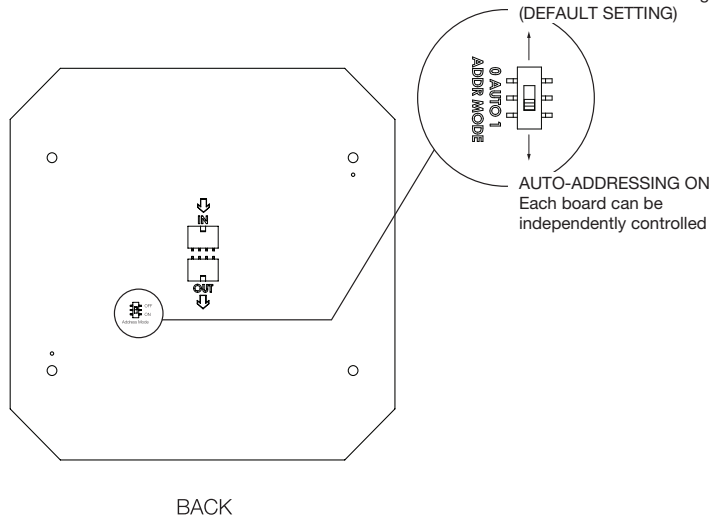

BACK

1PXL Board DW

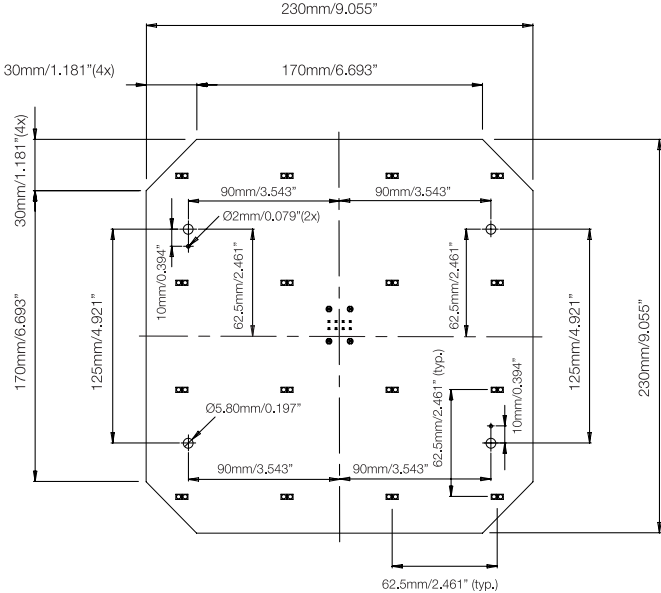

FRONT

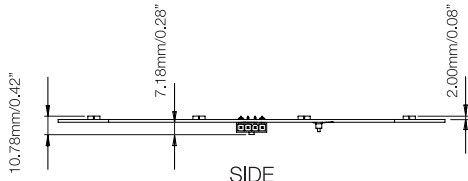

SIDE

AUTO-ADDRESSING CONFIGURATION:
 AUTO-ADDRESSING OFF
 All boards work as a single pixel
 (DEFAULT SETTING)

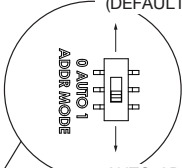

AUTO-ADDRESSING ON
 Each board can be independently controlled

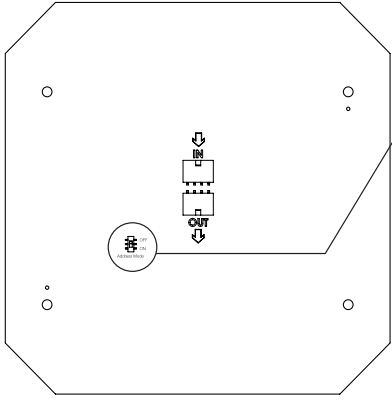

BACK

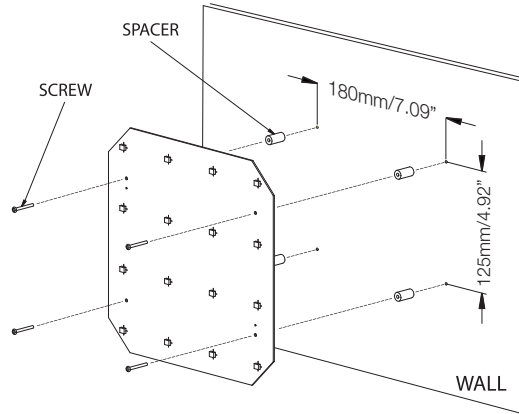

Multiple Board Mounting

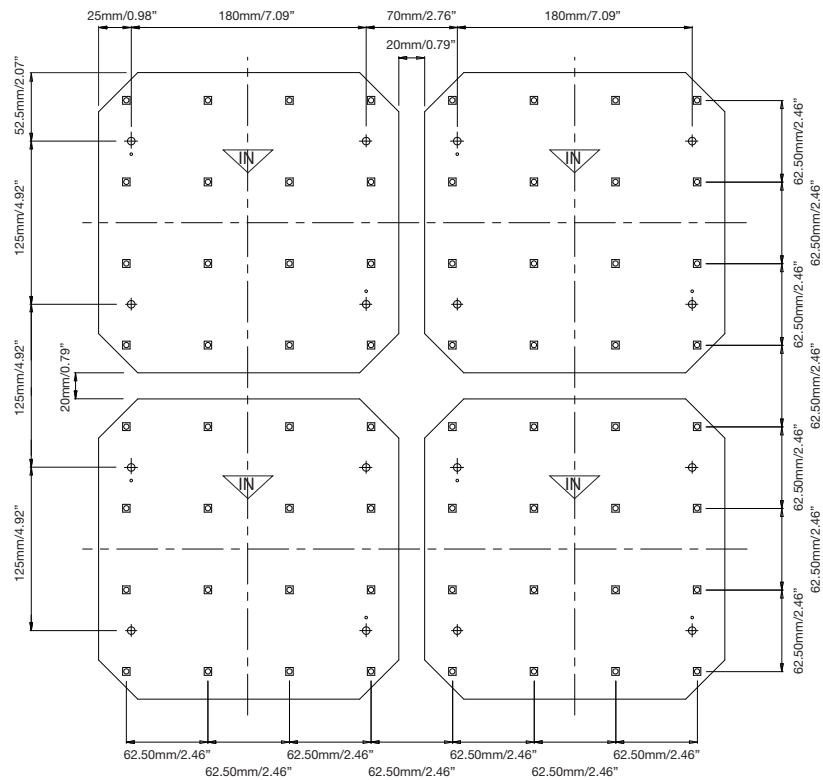

Mounting Accessories

4 x Nylon Spacers

4 x 35mm Screws

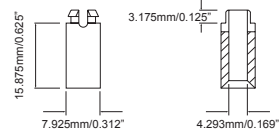

Nylon Spacer Dimensions

www.traxontechnologies.com

©2016 TRAXON TECHNOLOGIES - AN OSRAM BUSINESS. ALL RIGHTS RESERVED. TRAXON™, TX CONNECT®, ARE TRADEMARKS OF TRAXON TECHNOLOGIES. U.S. PATENTS, E.U. PATENTS, JAPAN PATENTS, OTHER PATENTS PENDING. SPECIFICATIONS ARE SUBJECT TO CHANGE WITHOUT NOTICE.

System Diagram - Butler S2

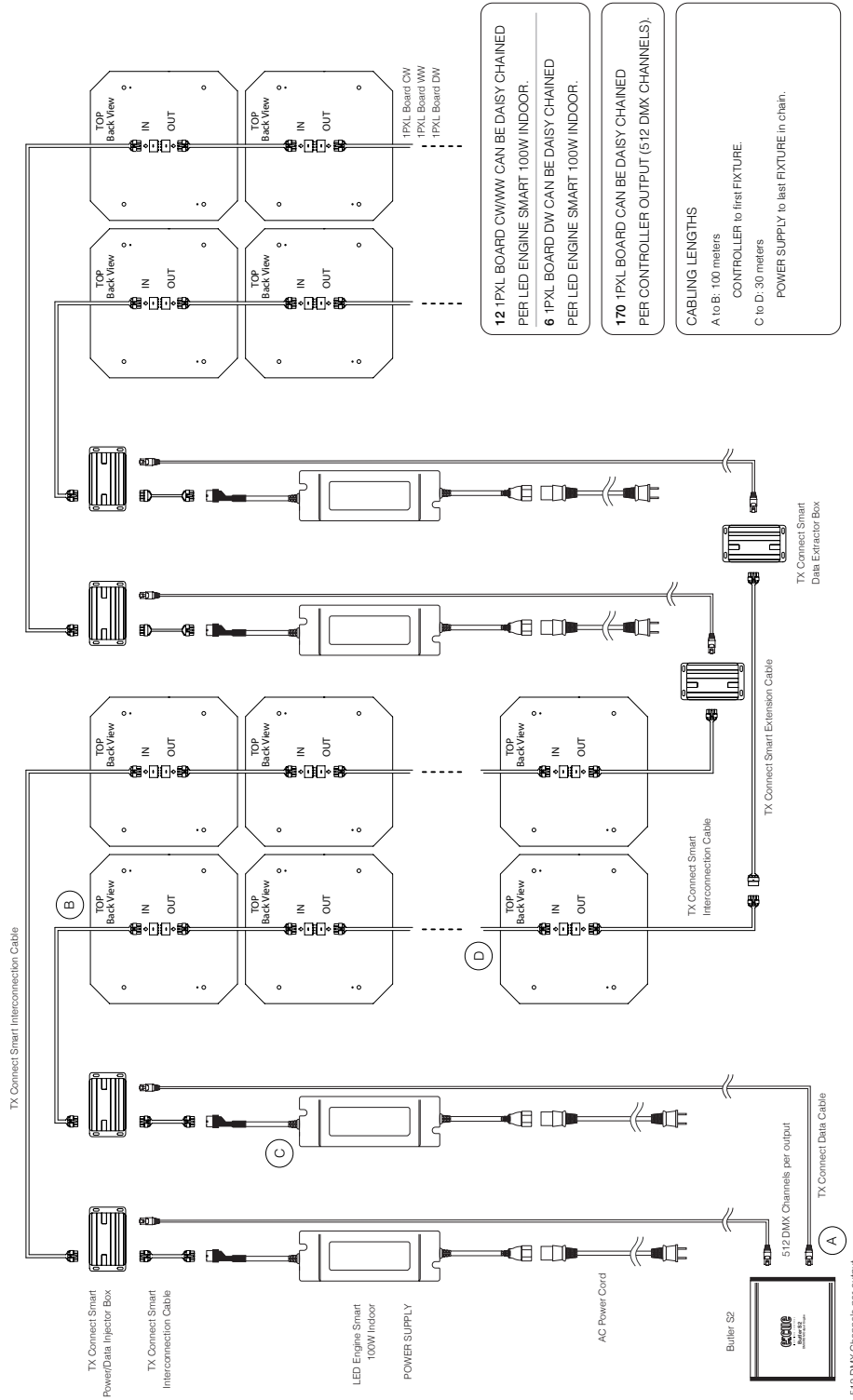

www.traxontechnologies.com

©2016 TRAXON TECHNOLOGIES - AN OSRAM BUSINESS. ALL RIGHTS RESERVED. TRAXON™, TX CONNECT®, ARE TRADEMARKS OF TRAXON TECHNOLOGIES. U.S. PATENTS, E.U. PATENTS, JAPAN PATENTS, OTHER PATENTS PENDING. SPECIFICATIONS ARE SUBJECT TO CHANGE WITHOUT NOTICE.



1PXL Board CW/WW/DW

Ordering

Fixtures

Model No.	Description	Item Code
MB.BO.5060003	1PXL Board CW	AA558590055
MB.BO.5070003	1PXL Board WW	AA558600055
MB.BO.5080003	1PXL Board DW	AA558620055

Standard Accessories (included in delivery)

Model No.	Description	Item Code
TI.IC.0030000	TX CONNECT Smart Indoor Interconnection Cable, 30cm/11.82"	A63420F0055
N/A	1x Board Mounting Kit (4x Nylon Spacers, 4x Mounting Screws)	N/A

TX Control

Model No.	Description	Item Code
EN.BU.0000001	Butler S2	AB436200031

TX Connect

Model No.	Description	Item Code
TI.ZI.0000100	TX CONNECT Smart Power/Data Injector Box	A704836003J
TI.DO.0000100	TX CONNECT Smart Data Extractor Box	A704842003J
TI.EC.0050000	TX CONNECT Smart Indoor Extension Cable, 0.5m/1.64ft	AA556350055
TI.EC.0100000	TX CONNECT Smart Indoor Extension Cable, 1m/3.28ft	A6342330055
TI.EC.0300000	TX CONNECT Smart Indoor Extension Cable, 3m/9.84ft	A6342410055
TI.EC.0500000	TX CONNECT Smart Indoor Extension Cable, 5m/16.4ft	AA580410055
TI.EC.1000000	TX CONNECT Smart Indoor Extension Cable, 10m/32.8ft	A6342680055
DI.IC.0100000	TX CONNECT Data Cable, 1m/3.28ft	AA556130055

TX Power

Model No.	Description	Item Code
PS.IA.0010000	LED Engine Smart 100W Indoor	AA624090055
PS.AC.0000100	AC Power Cord, 2m/6.6ft (EU)	AA553860055
PS.AC.0000300	AC Power Cord, 2m/6.6ft (UK)	AA556300155
PS.AC.0000400	AC Power Cord, 2m/6.6ft (AU)	AA556310055



©2016 TRAXON TECHNOLOGIES - AN OSRAM BUSINESS. ALL RIGHTS RESERVED. TRAXON™, TX CONNECT®, ARE TRADEMARKS OF TRAXON TECHNOLOGIES. U.S. PATENTS, E.U. PATENTS, JAPAN PATENTS, OTHER PATENTS PENDING. SPECIFICATIONS ARE SUBJECT TO CHANGE WITHOUT NOTICE.