





**SOURCE SPECIFICATIONS**

Source: 16 LEDs packaged in RGB

Optics: 120°

Cover Lens: -

Distribution: Symmetric direct illumination

CCT: -

**CANDELA DISTRIBUTION**

**LIGHT OUTPUT**

- Measured on: White
- Beam angle (50% I<sub>max</sub>): 114°

Color	Total Output (lm)	Power (W)	Efficacy (lm/W)
White	132.3	7.44	17.78
Red	37.65	3.84	9.80
Green	80.36	4.8	16.74
Blue	9.1	3.12	2.92

- Luminance: 710 cd/m<sup>2</sup> (nits)

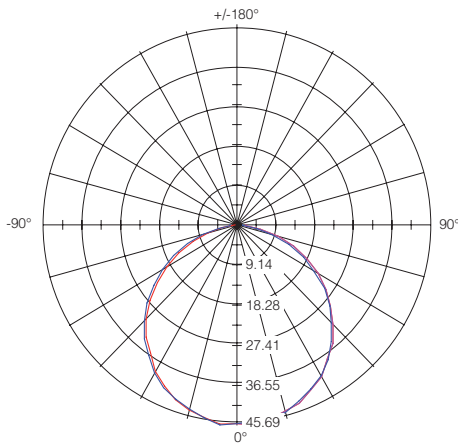

**ILLUMINANCE**

Distance	10cm/3.9"	25cm/9.8"	50cm/19.7"	75cm/29.5"	100cm/39.4"
Lux	4520	723	181	80	45
50% I <sub>max</sub> (diameter)	31cm/12.20"	77cm/30.31"	154cm/60.62"	231cm/90.94"	308cm/121.25"

- Measured on: White

**ILLUMINANCE DISTRIBUTION**

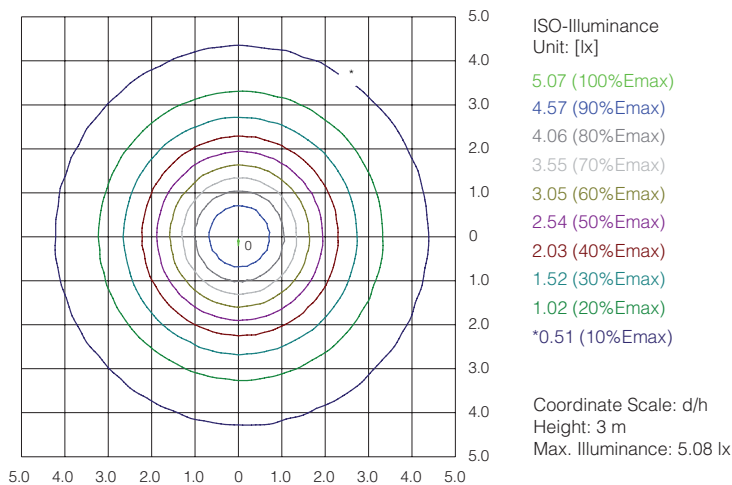

Photometric measurements are carried out by an independent laboratory. IES and LDT files are available for download from the Traxon website.

WWW.TRAXONTECHNOLOGIES.COM

© 2010 TRAXON TECHNOLOGIES ALL RIGHTS RESERVED. TRAXON™, TX CONNECT™, LUXILED™ ARE TRADEMARKS OF TRAXON TECHNOLOGIES. U.S. PATENTS, E.U. PATENTS, JAPAN PATENTS, OTHER PATENTS PENDING. SPECIFICATIONS ARE SUBJECT TO CHANGE WITHOUT NOTICE.

traxxon



16PXL Board RGB

Dimensions

TECHNICAL DRAWING

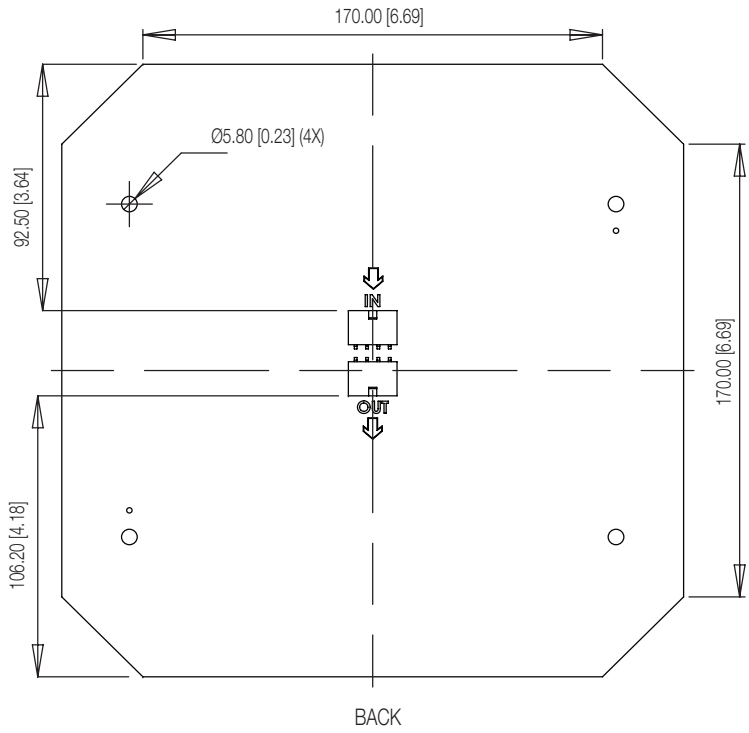

Dimensions in mm [in]

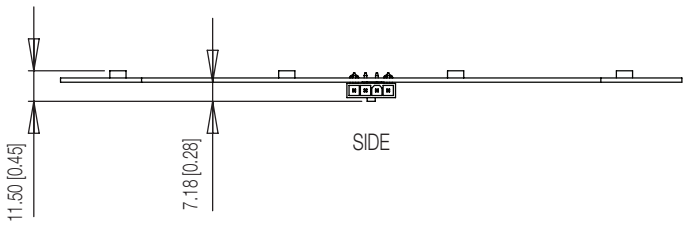
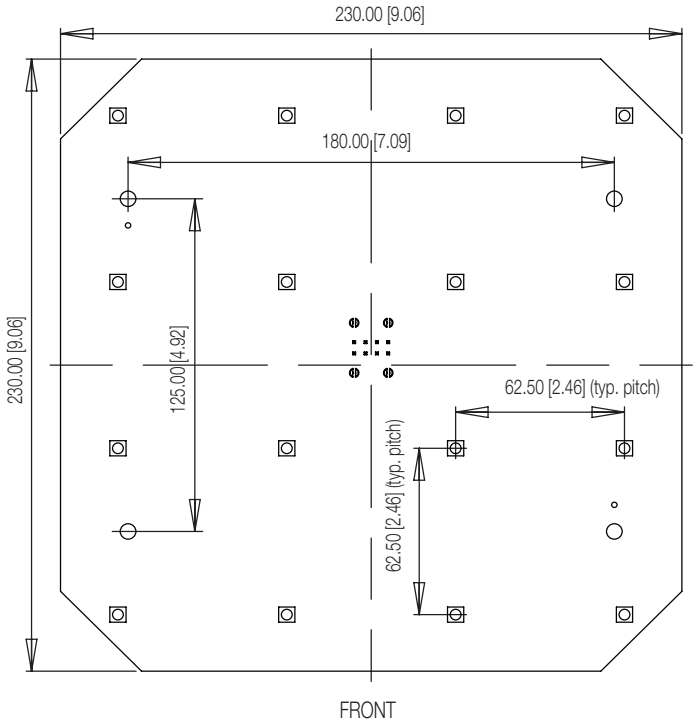



MOUNTING

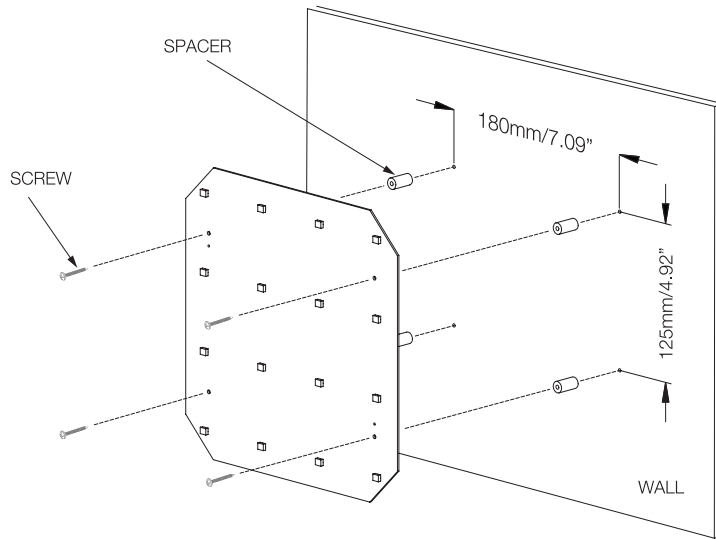

Mounting Accessories



4 x Nylon Spacers



4 x 35mm Screws

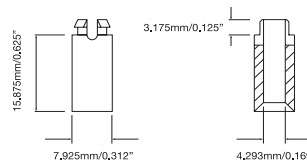

Nylon Spacer Dimensions

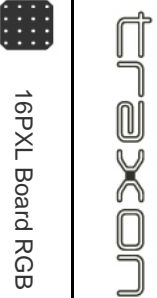

# System Diagram

## SYSTEM DIAGRAM

- 10x 16PXL BOARD RGB CAN BE DAISY CHAINED PER LED ENGINE SMART 100W INDOOR.
  - 10x 16PXL BOARD RGB CAN BE DAISY CHAINED PER MICRO SERVER OUTPUT (512 DMX CHANNELS).
- CABLING LENGTHS**
- A to B: 100 meters  
CONTROLLER to first FIXTURE.
  - C to D: 30 meters  
POWER SUPPLY to last FIXTURE in chain.

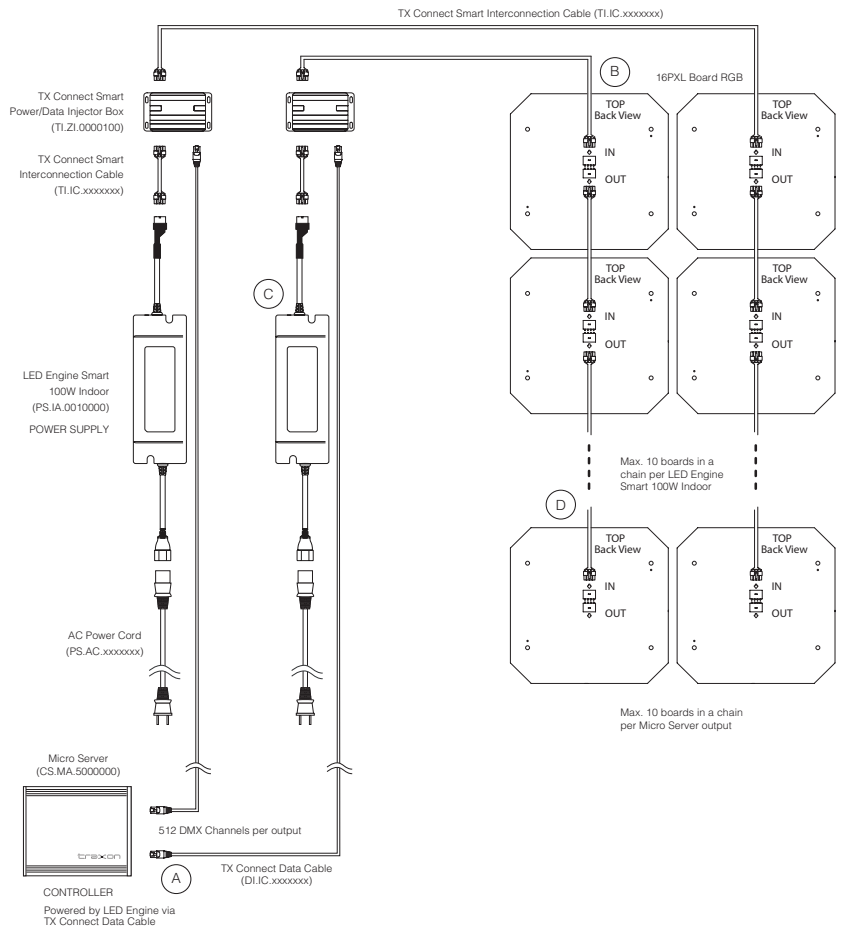



16PXL Board RGB

Accessories

#### STANDARD ACCESSORIES (included in delivery)

Model No.	Description
TI.IC.0030000	TX CONNECT Smart Indoor Interconnection Cable, 0.3m / 11.82"
	1x Board Mounting Kit (4x Nylon Spacers, 4x Mounting Screws)

#### ADD-ON STRIP AND BOARD

Model No.	Description
MB.ST.5311000	4PXL Add-On Strip (62.5)
MB.BO.5315000	4PXL Add-On Board (62.5)

#### TX CONTROL

Model No.	Description
CS.MA.5000000	Micro Server

#### TX CONNECT

Model No.	Description
TI.ZI.0000100	TX CONNECT Smart Power/Data Injector Box
TI.DO.0000100	TX CONNECT Smart Data Extractor Box
TI.PI.0000100	TX CONNECT Smart Power Injector Cable.
TI.EC.0050000	TX CONNECT Smart Indoor Extension Cable, 0.5m / 1.64ft
TI.EC.0100000	TX CONNECT Smart Indoor Extension Cable, 1m / 3.28ft
TI.EC.0300000	TX CONNECT Smart Indoor Extension Cable, 3m / 9.84ft
TI.EC.0500000	TX CONNECT Smart Indoor Extension Cable, 5m / 16.4ft
TI.EC.1000000	TX CONNECT Smart Indoor Extension Cable, 10m / 32.8ft
DI.IC.0100000	TX CONNECT Data Cable, 1m/3.28ft

#### TX POWER

Model No.	Description
PS.IA.0010000	LED Engine Smart 100W Indoor
PS.IB.7030000	LED Engine Smart 300W Indoor
PS.AC.0200100	LED Engine Garage 220V (houses 3x PS.IB.7030000)
PS.AC.0200200	LED Engine Garage 110V (houses 3x PS.IB.7030000)
PS.AC.0000100	AC Power Cord (EU)
PS.AC.0000200	AC Power Cord (US)
PS.AC.0000300	AC Power Cord (UK)
PS.AC.0000400	AC Power Cord (AU)
PS.AC.0000500	AC Power Cord (JP)